

WebiSmarts System

Weatherproof Bracket for Exhaust Stack GM-42 Detector CAT: BAK-1550

Radiation Detection Division

WebiSmarts utilizes two gamma detectors to calculate and display the concentration of effluent through the exhaust stack and thereby create historical graphs of concentration and a report of activity released between two dates. Both detectors are inserted into stainless steel brackets within the exhaust stack and covered by a PVC jacket on the outside. **The GM-42 Detector is used to measure high releases of effluent in cases where the sensitive PM-11 has saturated.**

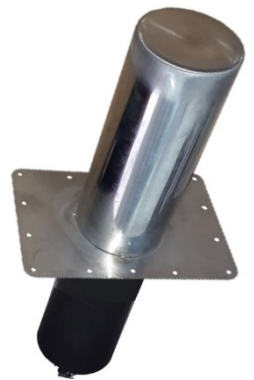

* Silicon or any other sealer not supplied

Bracket for Exhaust Stack

Includes:

Stainless Steel Bracket

Rubber Seal

PVC Weatherproof Jacket

Detector Spacer

PVC Cable Cover

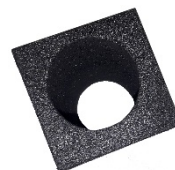
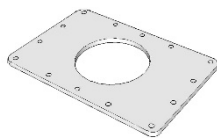
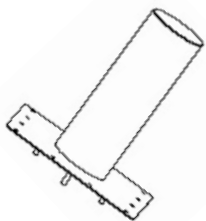

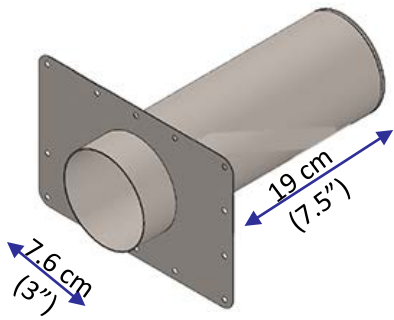

Material: Stainless Steel

Other Brackets that may interest you

PM-11 Bracket

BAK-1563

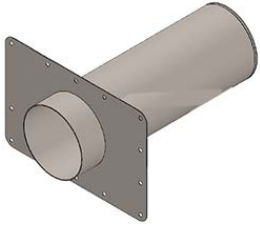

Flowmeter Bracket

BAK-1160



DPU-3 Wall Bracket

MEC-9285

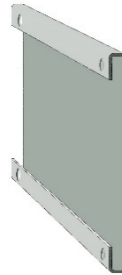

Standard 1" Detector Bracket BAK-1200



Advanced Universal Detector Bracket

BAK-0194



ROTEM INDUSTRIES reserves the right to change specifications without advance notice