

WebiSmarts System

ROTEM RadMon Detector Bracket for Exhaust Stack (Waterproof) PCAT: P5451GR

Radiation Detection Division

WebiSmarts utilizes two gamma detectors to calculate and display the concentration of effluent through the exhaust stack and thereby create historical graphs of concentration and a report of activity released between two dates. Both detectors are inserted into stainless steel brackets within the exhaust stack and covered by a PVC jacket on the outside.

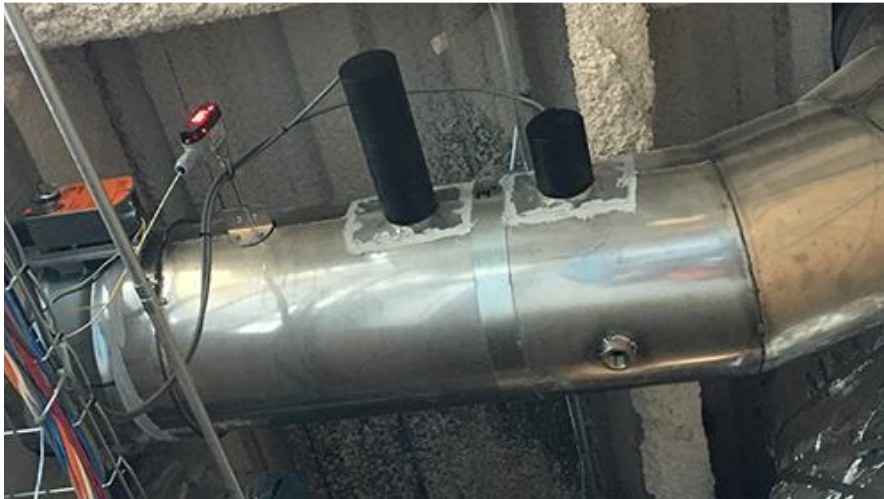

* Silicon or any other sealer not supplied

Bracket for Exhaust Stack

Includes:

Stainless Steel Bracket

Rubber Seal

PVC Weatherproof Jacket

PVC Cable Cover

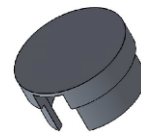
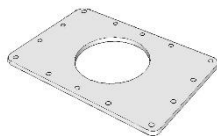
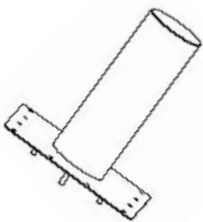

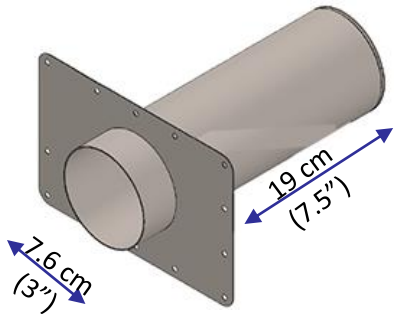

Other Brackets that may interest you

PM-11 Bracket
P5451GR

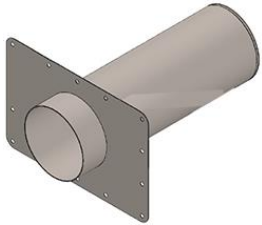

Flowmeter Bracket
P5451GE

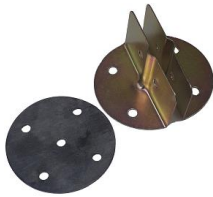

Area Monitor Bracket
P5451GJ



Detector Bracket



ROTEM INDUSTRIES reserves the right to change specifications without advance notice